



### Durability

TabZEROfile folders with reinforced **eternafilm** on the end tab are one of the most durable records management file folder products available. **Eternafilm** is an environmentally friendly protective coating.



[www.tabZEROfile.com](http://www.tabZEROfile.com)

*Trim your folders to specific sizes. See page 16 for more information on folder trimming services.*

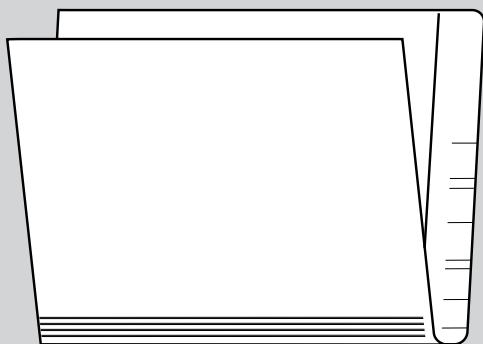

### Standard Side Tab File Folders (335gsm)

tabZEROfile folders are a truly environmentally friendly product. By taking a holistic view of the product manufacturing lifecycle, including packaging, transportation and disposal, DATAFILE is able to offer a 100% recyclable, carbon neutral, acid free folder family made from 100% recycled materials. Even the packaging is recyclable and reusable! This standard 335gsm, carbon neutral folder is durable for most active filing applications.

Product#	Description	Dimensions (mm)
CN1258	30mm expansion, A4, White	240H x 330W
CN1228	30mm expansion, Legal (FC), White	240H x 390W

### Reinforced Side Tab File Folders (335gsm)

For extra durability, this 335gsm carbon-neutral folder offers a long lasting eternafilm™ reinforced side tab. Available in clear eternafilm plus 10 different colours for segmenting groups of files.

Product#	Description	Dimensions (mm)
CN1259-X	30mm expansion, A4, Eternafilm	240H x 330W
CN1229-X	30mm expansion, Legal (FC), Eternafilm	240H x 390W

Replace "-X" with appropriate colour suffix: C-Clear, 0-Pink (Salmon), 1-Cranberry (Red), 2-Light Orange, 3-Dark Orange, 4-Light Green, 5-Dark Green, 6-Light Blue, 7-Purple, 8-Lavender (Mauve), 9-Brown.

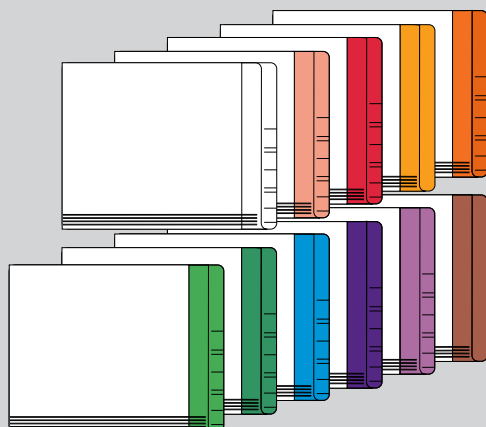

To coincide with the release of the **tabZEROfile** product range, DATAFILE is changing from (F) series eternafile to the new (CN) series **tabZEROfile**.

**tabZEROfile** products are the ideal solution for:

1. Clients currently using the standard white folders.
2. Clients using F1128, F1158, F1229-C, F1229-X and F1259-X products.
3. Organisations that place a priority on environmentally friendly products.

### Product Pricing

**tabZEROfile** folders are priced the same as standard DATAFILE folders (models noted above).



CARBON NEUTRAL



REDUCED AND REUSABLE PACKAGING



SUSTAINABLE FORESTRY INITIATIVE



ACID FREE PAPER

### Expansion Pocket with Full Side Tab (600gsm)

These high quality carbon-neutral expansion file pockets offer maximum filing capacity for storage of bulky documents, computer printouts and documents of assorted sizes. Triple thick front and back panels are 600gsm. Full side tab pockets have Tyvek® gussets and will expand to 100mm.

Product#	Description	Dimensions (mm)
CN1844	100mm expansion, Legal (FC)	240H x 390W
CN1544	100mm expansion, NZFC (355mm W)	240H x 355W



### Pressboard Expansion Folder with Side Tab (550gsm)

For heavy duty filing applications, these 550gsm carbon-neutral pressed file expansion folders are available in legal size, with 50mm or 75mm expansion.

Product#	Description	Dimensions (mm)
CN1722	50mm expansion, Legal (FC)	240H x 390W
CN1546	75mm expansion, Legal (FC)	240H x 390W

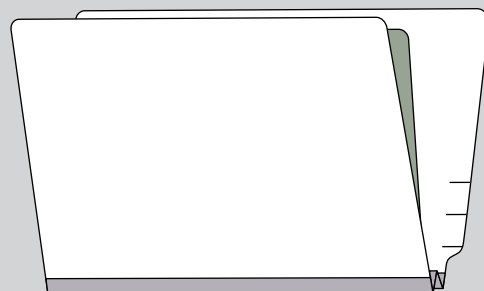



# White with Color Side Tabs

DATAFILE

FOLDERS

## White Folders with Reinforced, Coloured Side Tabs

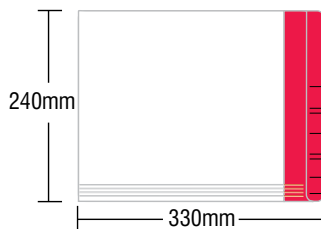

### A4 (335gsm)

Product#	Description
CN1259-X	30mm expansion, A4, Eternafilm

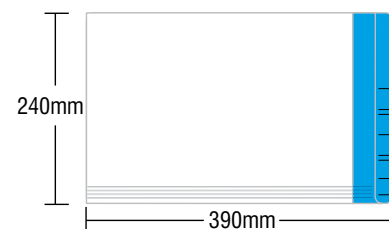

### LEGAL (FC) (335gsm)

Product#	Description
CN1229-X	30mm expansion, FC, Eternafilm

Replace "-X" with appropriate colour suffix below :

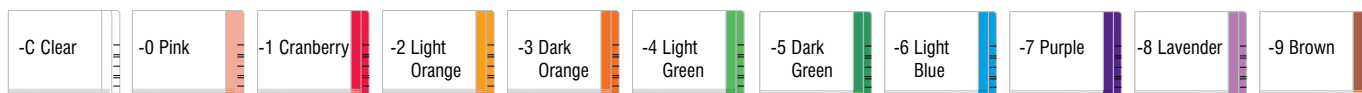

Our commitment to the environment has been recognised by the European Union as meeting their EN13432 standard for biodegradable and compostable packaging. Eternafilm also meets the criteria set out by the Biodegradable Products Institute of America, to meet US Standard Specifications for Compostable Plastics ASTM D-6400-99.

## The DATAFILE Difference

At a time when protecting the environment and meeting environmental initiatives is a priority, many of our customers are reassured by the fact that DATAFILE folders are made with Eternafilm, an environmentally friendly and totally biodegradable reinforcement film. This makes every DATAFILE folder fully recyclable for environmental piece of mind.

The Folder of Choice is the most durable folder made – perfect for active filing systems where folders are frequently accessed, retrieved or transferred. DATAFILE gives you full-cut eternafilm reinforced tabs. The tab is double thick for rigidity and coated with eternafilm for durability.

## Folder Paper Comparison (Magnification)



# Standard & Manilla

## FOLDERS

DATAFILE

### Manilla Top/Side Tab Folders

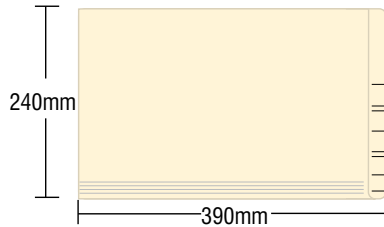
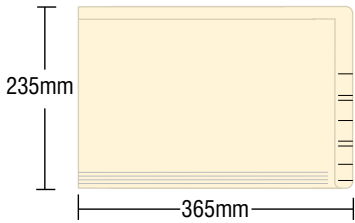

#### A4 TOP/TWIN TAB (213gsm)

Product#	Description
1156-00	25mm expansion, A4, Buff, Top Tab
1156-TT	25mm expansion, A4, Buff, Twin Tab

#### LEGAL (FC)

Product#	Description
F1128M	30mm expansion, 213gsm, FC, Buff, Side Tab
1142-BF	30mm expansion, 360gsm, FC, Buff, Side Tab

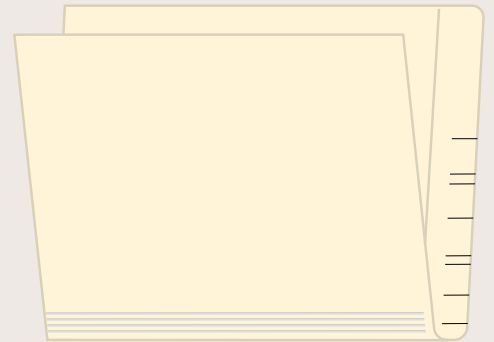

*Made from cost effective, light grade board. Designed for high volume, quick turn around applications.*

### White Side Tab & Reinforced Side Tab Folders

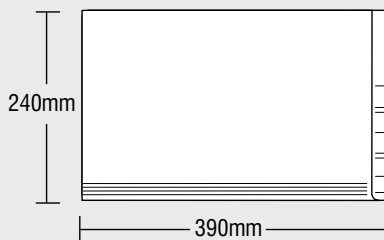
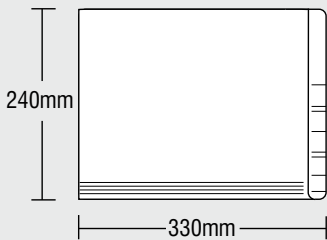

#### A4

Product#	Description
F1158	30mm expansion 213gsm, A4, White
CN1258	30mm expansion, 335gsm, A4, White

#### LEGAL (FC)

Product#	Description
CN1128	30mm expansion, 213gsm, FC, White
CN1228	30mm expansion, 335gsm, FC, White
1142-00	40mm expansion, 360gsm, FC, White

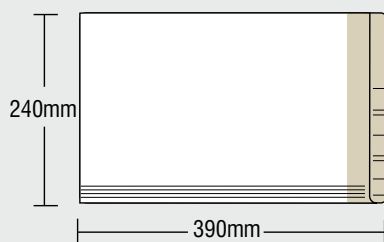
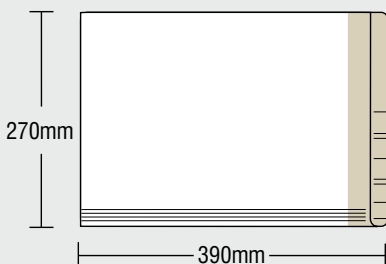

#### LEGAL (FC) (280gsm)

Product#	Description
M10122-01	50mm expansion, FC, Eternafilm

#### LEGAL (FC) (360gsm)

Product#	Description
1142-01	40mm expansion, FC, Eternafilm

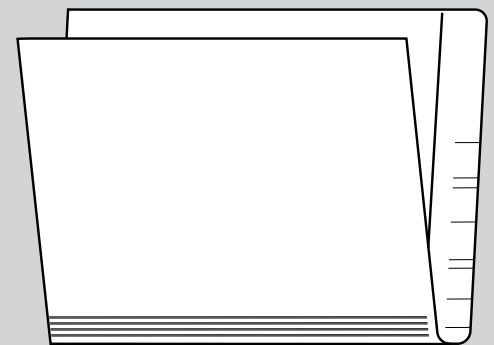

*A durable and high quality range of folders, with your choice of plain or reinforced end tabs.*

*Print your logo or subject table on your manilla and white side tab folders. See page 16 for more on folder printing services.*

# Pressboard Expansion

DATAFILE

FOLDERS

## For heavy-duty filing applications

Pressboard Folders meet your system's need to provide enhanced storage of critical documents. Made of durable **550gsm** material, with or without fasteners these folders last several lifetimes.

### Printed Score Marks

Located to assist in the correct label placement, insuring accurate and consistent color coding.

### The "Notch"

Designed undercut so folders fit neatly on shelves with a front lip.

### Tyvek® Tape

Virtually indestructible Tyvek connects front panel to back panel forever!

*Add your favourite fastener to your folder. DATAFILE will install, box and ship your fastener installed folders for you. See page 17 for more.*

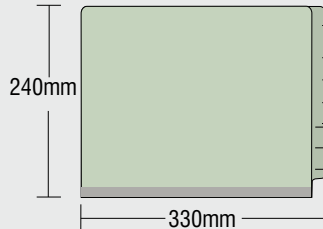
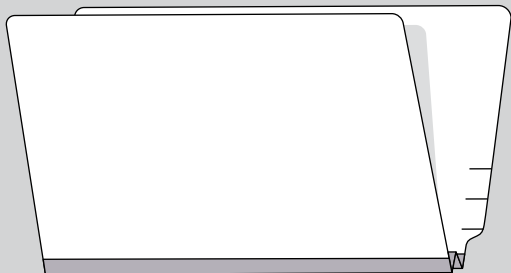
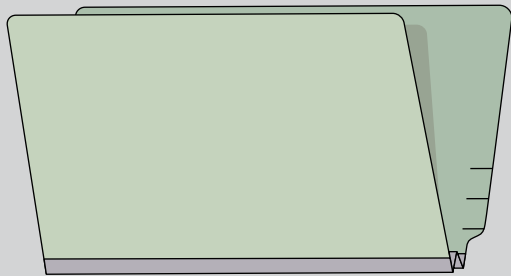
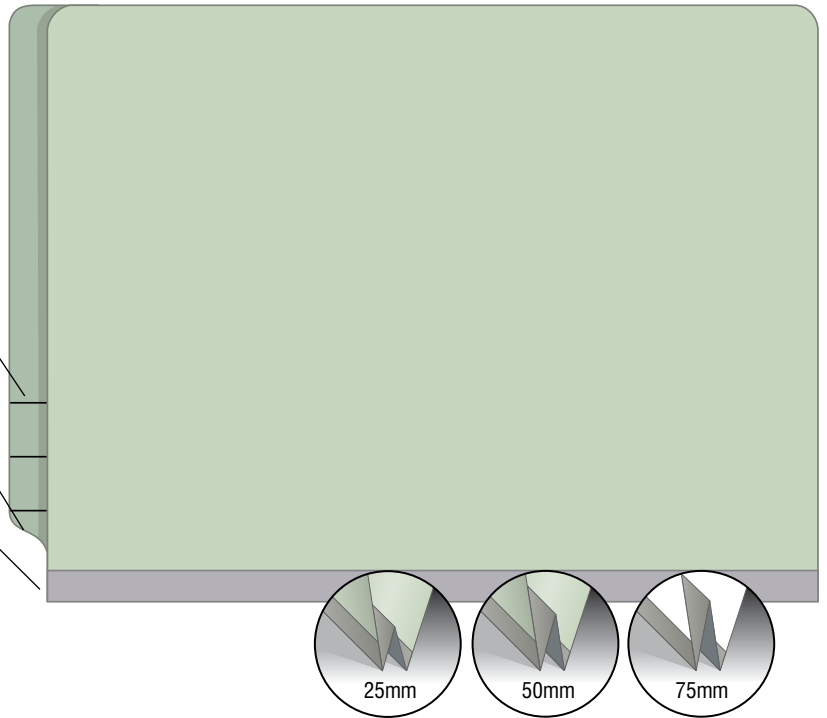

### A4 (550gsm)

Product#	Description
F1751	25mm expansion, A4, Green
F1752	50mm expansion, A4, Green

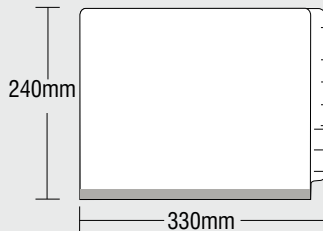

### A4 (550gsm)

Product#	Description
CN1752	50mm expansion, A4, White

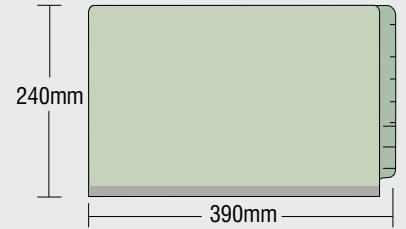

### LEGAL (FC) (550gsm)

Product#	Description
F1721	25mm expansion, FC, Green
F1722	50mm expansion, FC, Green

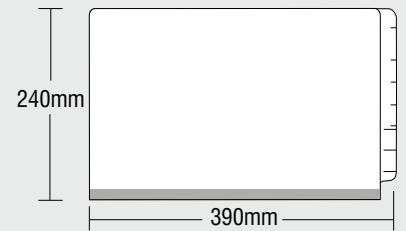

### LEGAL (FC) (550gsm)

Product#	Description
CN1722	50mm expansion, FC, White
CN1546	75mm expansion, FC, White

# Pressboard Classification

## FOLDERS

### Need to separate your files?

Classification folders allow you to divide large files into logical storage groups. The option to install multiple dividers and fasteners can help maximise your filing surfaces.

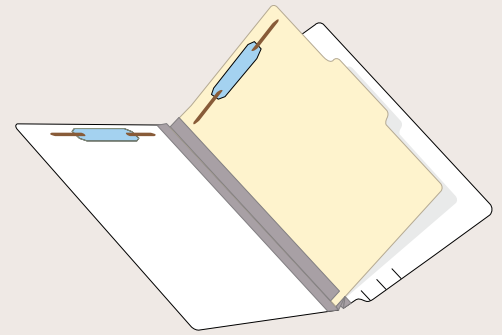
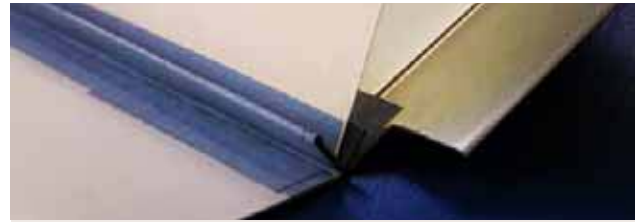
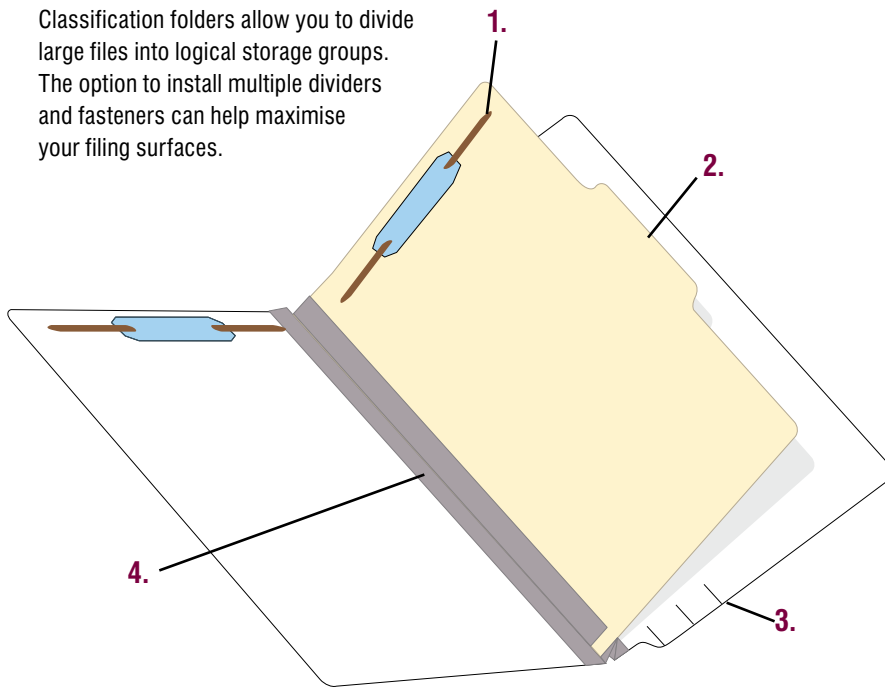

\*1 divider with 4 heatseal fasteners.

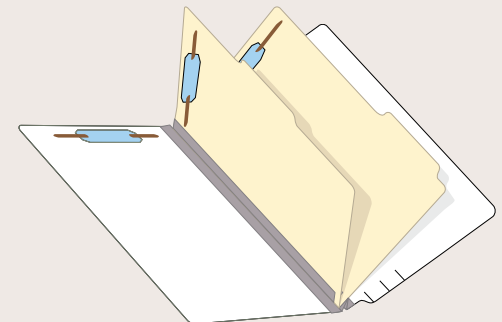

\*2 dividers with 6 heatseal fasteners

## Pressboard Classification Folders

### 1. Standard Fasteners

Each section contains fasteners to securely fasten your documents and keep them in date order. 50mm bonded fastener on position 1 & 3 of folder, and heatseal fastener on each divider.

### 2. 360gsm Manila Dividers

### 3. Printed Score Marks

Located to assist in the correct label placement, insuring accurate and consistent color coding.

### 4. Tyvek® Tape

Virtually indestructible Tyvek connects front panel to back panel forever!



## LEGAL (FC)

Product#	Description
CN102313	75mm expansion, FC, 2 Dividers
CN102213	50mm expansion, FC, 1 Divider
F1923	Pressboard Expansion Well Log File, 2 Manilla Dividers & 100mm expansion pocket

*Need to add more components to your files? Let DATAFILE apply, box and ship your customised folders for you. See page 16 & 17 for more.*

## Dividers

One divider files permit 50mm of expansion and separation into 4 sections. Two divider files permit 75mm of expansion and separation into 6 sections\*.

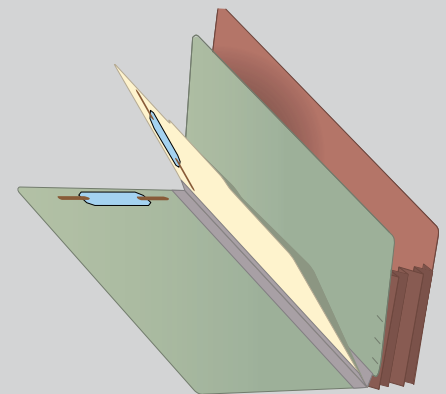

## Log Files

Need more than dividers? Additional pockets can be inserted or added, such as our F1923 Log File. Please call for a quote.



# Expansion Pocket

DATAFILE

FOLDERS

## Maximum Filing Capacity

DATAFILE expansion pocket folders are durable, easy to use, and constructed of rugged, tear resistant, **600gsm** materials to prevent loss of important documents. **Tyvek®** reinforced gussets ensure maximum durability and protection while providing optimal storage capacity.

Cost effective **F1870** paper expansion pockets are also available for more lightweight filing applications where quick & easy storage is a priority.

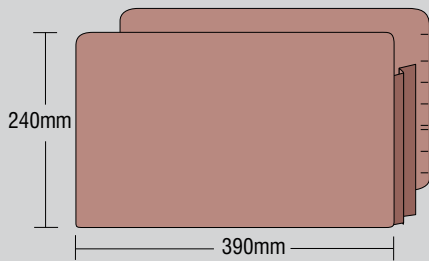
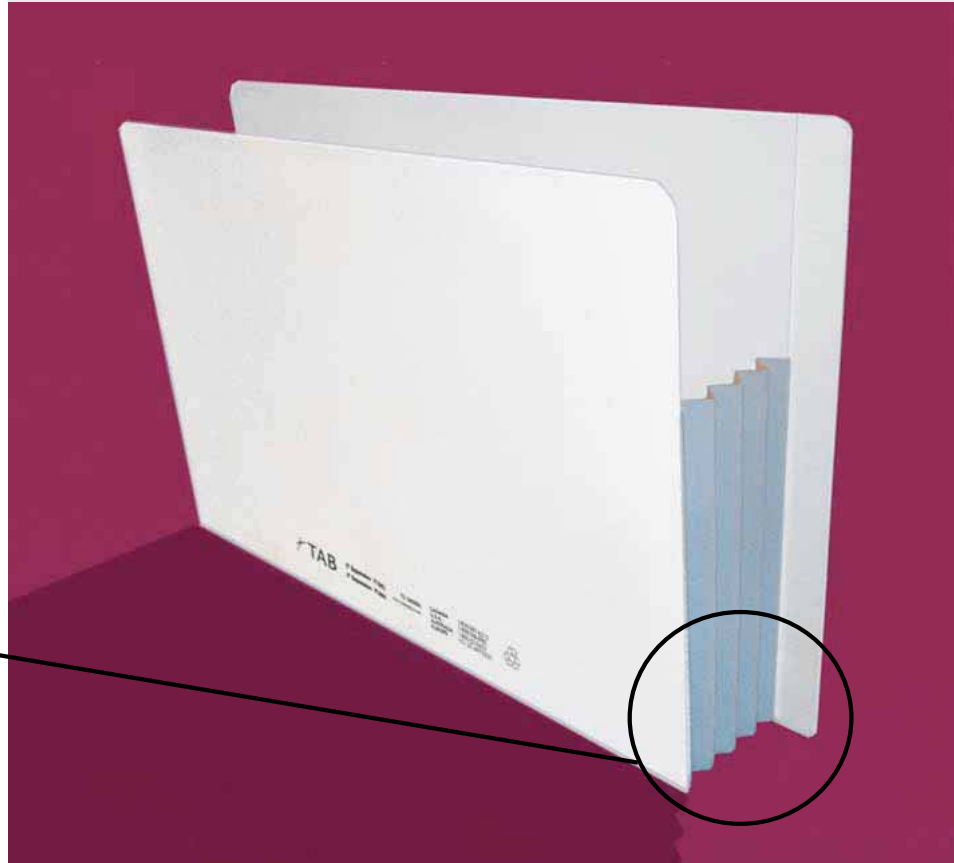
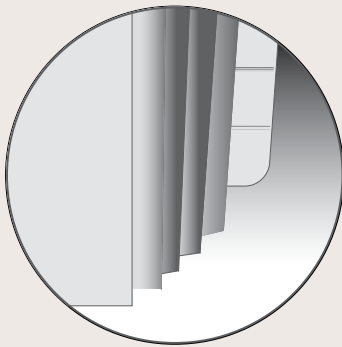

### LEGAL (FC) (600gsm)

Product#	Description
F1842	50mm expansion, FC, Brown

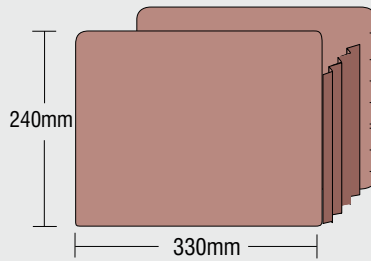

### A4 (600gsm)

Product#	Description
F1854	100mm expansion, A4, Brown

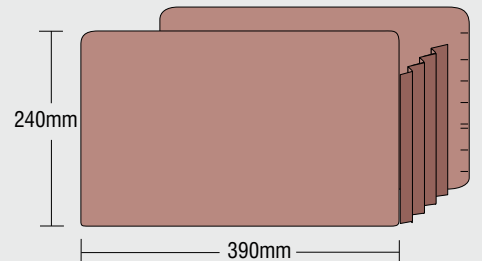

### LEGAL (FC) (600gsm)

Product#	Description
F1844	100mm expansion, FC, Brown

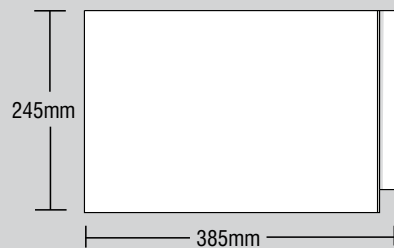

### LEGAL (FC) (280gsm)

Product#	Description
F1870	25mm expansion, FC, White

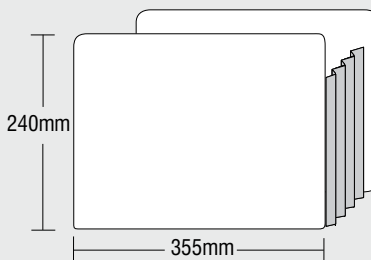

### NZFC (600gsm)

Product#	Description
CN1544	100mm expansion, NZFC (355mm W), White

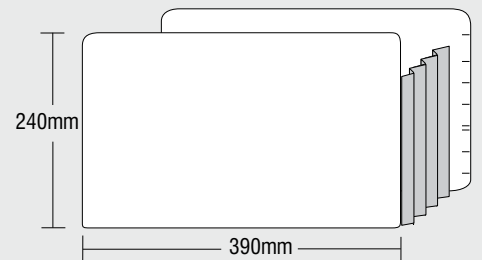

### LEGAL (FC) (600gsm)

Product#	Description
CN1844	100mm expansion, FC, White

# FORTIfile Range

## FOLDERS

### Family of file products with Eternafilm

FORTIfile folders provide the most durability for your everyday filing requirements. DATAFILE FORTIfile folders are fully coated with Eternafilm. Eternafilm is an environmentally friendly, protective coating that is applied over the entire folder's outer surface, increasing the strength and rigidity of every DATAFILE FORTIfile product.

- Faster Retrieval
- Highly Durable
- Environmentally Friendly
- Write on, Erase, Reuse

### FORTIfile - Folders

FORTIfile folders have a full double reinforced side tab. FORTIfile folders are available in A4 and Legal (FC) sizes.

Product#	Description	Dimensions (mm)
FF4259-XX	A4, FORTIfile Folder	240H x 330W
FF4229-XX	FC, FORTIfile Folder	240H x 390W

Replace "-XX" with appropriate colour suffix, e.g. -HB for Honey Brown.

### FORTIfile - Pressed Files

FORTIfile pressed files are the answer for heavy duty filing applications and expand to 50mm.

Product#	Description	Dimensions (mm)
FF4752-XX	A4, 50mm expansion, FORTIfile Pressed	240H x 330W
FF4722-XX	FC, 50mm expansion, FORTIfile Pressed	240H x 390W

Replace "-XX" with appropriate colour suffix, e.g. -HB for Honey Brown.

### FORTIfile - Classification Folders

FORTIfile classification folders have built in dividers to segment information within a highly durable folder and have 50mm or 75mm expansion capabilities.

Product#	Description	Dimensions (mm)
FF4022-XX	FC, 50mm expansion, 1 divider, FORTIfile Classification	240H x 390W
FF4023-XX	FC, 75mm expansion, 2 dividers, FORTIfile Classification	240H x 390W

Only available in -PW (Pearl White), -AB (Azure Blue), -SY (Summer Yellow).

### FORTIfile - Expansion Pockets

FORTIfile high quality expansion pockets offer maximum filing capacity for storage of bulky and assorted sizes of documents. Full side tab pockets have Tyvek gussets and can expand to 125mm.

Product#	Description	Dimensions (mm)
FF4855-XX	A4, 125mm expansion, FORTIfile Pocket	240H x 330W
FF4845-XX	FC, 125mm expansion, FORTIfile Pocket	240H x 390W

Replace "-XX" with appropriate colour suffix, e.g. -HB for Honey Brown.

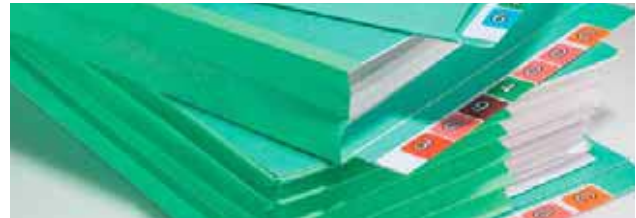

<b>AB</b>	Azure Blue	<b>MB</b>	Mocha Brown
<b>PW</b>	Pearl White	<b>MG</b>	Mint Green
<b>SY</b>	Summer Yellow	<b>CR</b>	Cranberry Red
<b>HB</b>	Honey Brown		

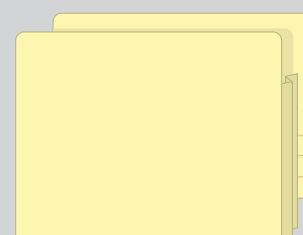
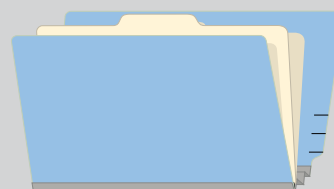
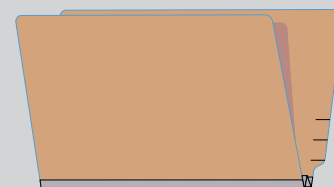





# Heavy Duty 70mm Expansion File

DATAFILE

FOLDERS



**Springclips** allow for gradual file growth and for space efficient filing.



**D-Ring fasteners** ensure fast and efficient access to critical documents.

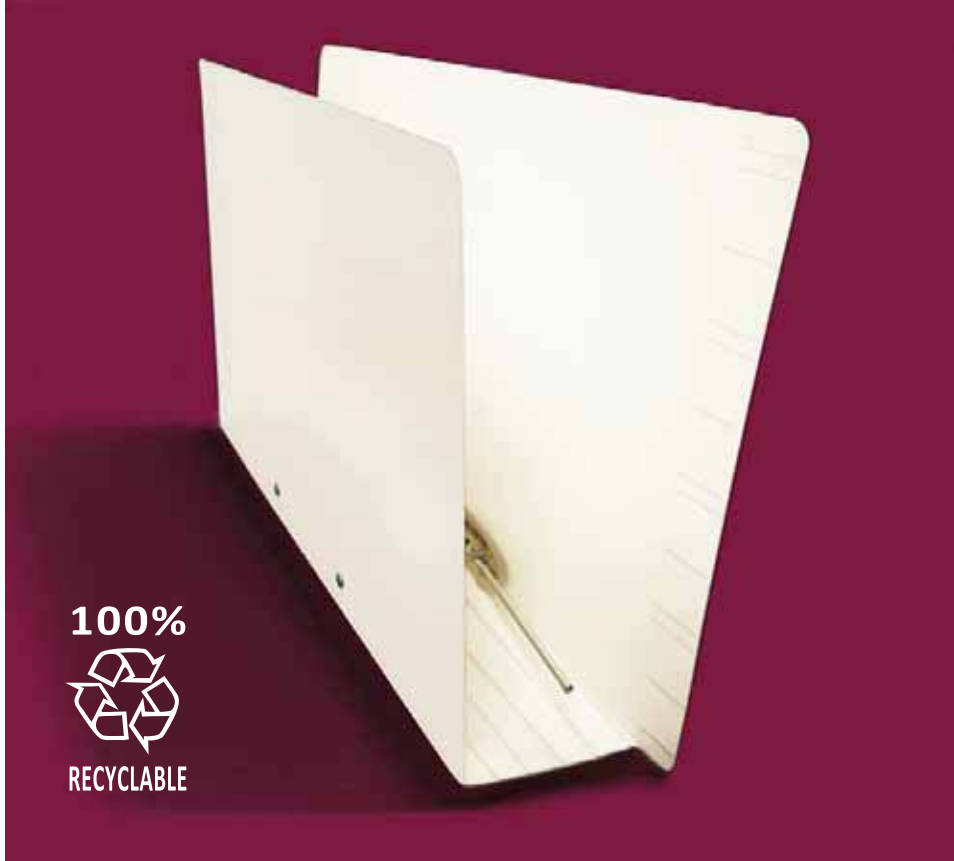

100%  
  
 RECYCLABLE

## A Low-Cost Expansion Alternative

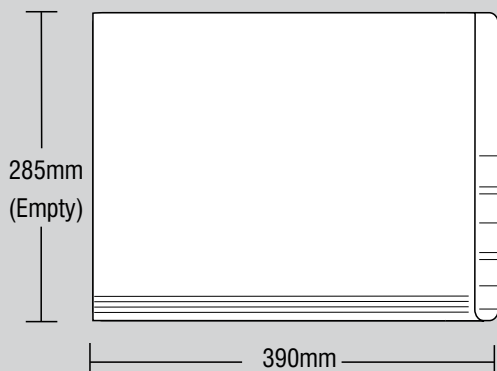
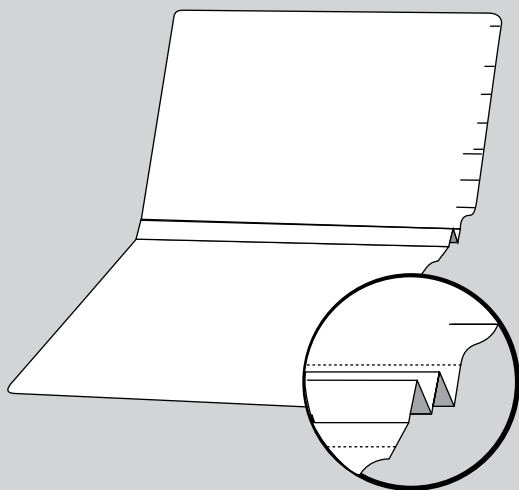

These high quality 70mm expansion files offer maximum filing capacity for large documents and are a perfect alternative to lever arch files. They are coated in DATAFILE's environmentally friendly **Eternafilm**, so you can be assured of their strength and durability.

- **Eternafilm** is 100% recyclable, unlike a Mylar laminate or plastic coating used on other files in the marketplace, and will conform with the strictest environmental company policies.
- As an alternative to the lever arch, this heavy duty lateral file can provide you with up to 40% better space utilisation. This is achieved through better use of vertical space on each shelf where material is stored. A typical 1980H cabinet can store 7 levels of lateral files vs. 5 levels of lever arch.
- The file is available with several fastener options, including the Springclip fastener and D-Ring fastener (available in various sizes).
- Available in our standard length of 390mm, 370mm or 355mm.

### DATAFILE Heavy Duty 70mm Expansion File (390gsm)

Product#	Description	Dimensions (mm)
FF4522-PW	70mm expansion, FC, Pearl White	250H x 390W (Full) 285H x 390W (Empty)

### Additional Installation Options

Install#	Description	Unit Qty.
5006-SP	Springclip Fastener	Each
5007-D35	D-Ring Clip Fastener, 2 Ring, 35mm	Each
5007-D70	D-Ring Clip Fastener, 2 Ring, 70mm	Each

# Heavy Duty 70mm Lateral Lever Arch & D-Ring Files

FOLDERS

DATAFILE

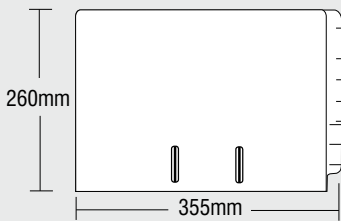
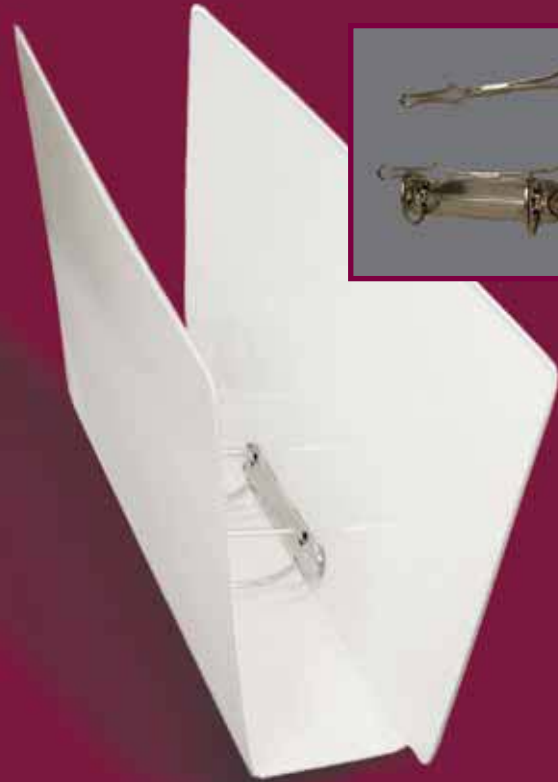

**NZFC - Lever Arch**

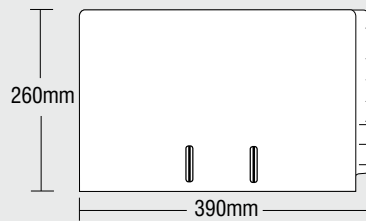

**LEGAL (FC) - Lever Arch**

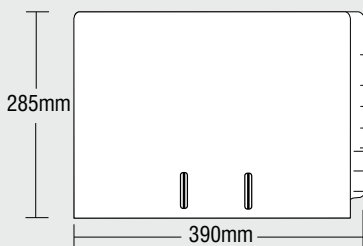

**FC-XL - Lever Arch**

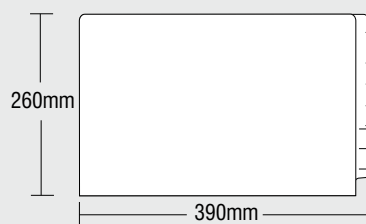

**LEGAL (FC) - D-Ring**

## DATAFILE Heavy Duty 70mm Lever Arch & D-Ring Files

Product#	Description	Dimensions (mm)
F4555	850gsm, NZFC, Lever Arch	260H x 355W
F4575	850gsm, FC, Lever Arch	260H x 390W
F4285	850gsm, FC-XL, Lever Arch	285H x 390W
F4570	776gsm, FC, D-Ring, 2 Rings	260H x 390W
F4570-D3	776gsm, FC, D-Ring, 3 Rings	260H x 390W

These high density, 70mm wide lateral side tab Lever Arch & D-Ring files offer maximum capacity for large documents and are a perfect alternative to standard upright lever arch files. The files can also be placed directly into archive boxes if required.

- As an alternative to the lever arch, these heavy duty lateral files can provide you with up to 40% better space utilisation. This is achieved through better use of vertical space on each shelf where material is stored. A typical 1980H cabinet can store 7 levels of lateral files vs. 5 levels of lever arch.
- With a full side tab to provide you with the maximum amount of space to color code your files, you can identify your folders on the side to speed up filing and retrieval times.

### Printing (Page 21)

Inside or outside. Back or front. 100 or 100,000. One or many colors. Your artwork. Our artwork. DATAFILE can print whatever you want, wherever you want it on a folder.

### Folder Trimming (Page 21)

Trim your files to fit your specific folder width. Ideal for when you have to match an existing file or make the folder sit on a non-standard storage shelf.

### Built to Suit Your Needs

From customised folder design & printing to installing the accessories you require into all your folders, DATAFILE can tailor build a folder to suit whatever need you have. Or, you can build it yourself with any of the products from DATAFILE's broad range of easy "Do-It-Yourself" accessories.

**Get DATAFILE to prepare, box and ship your file folders to your specific requirements.**

### Pockets, Inserts & Guides (Page 18 & 19)

Want to keep small items from falling out of your file? Add a clear pocket in one or several locations. From credit cards to letter size documents these factory installed pockets can improve your information process.

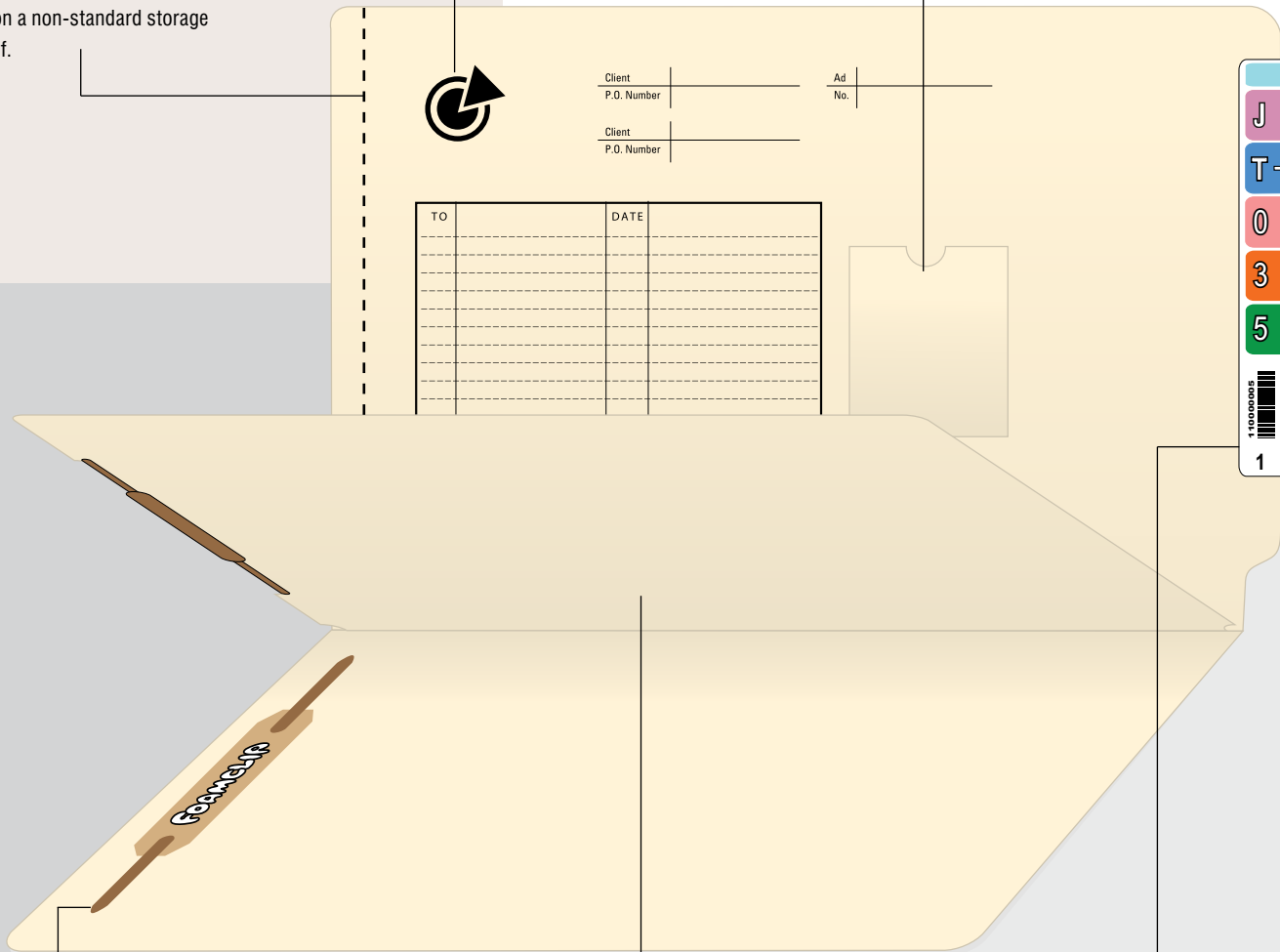

### Fasteners (Page 17)

Need to permanently attach documents to your folder? Use these fasteners to convert your plain manila folder to a fastener folder quickly and permanently! From a simple self adhesive fastener, to a Tip Back Patch, or use a Dataclip fastener. Dataclips permit you to save time allowing you to interfile without removing pages.

### Dividers (Page 20)

Keep information in organised groups within your folder with installed dividers. Optional twin pronged fasteners allow for attaching documents on either side of the divider.

### Color Coding Labels (Page 22)

TABQuik Color Coding Labels improve all your filing activities in file and out of file. Coding the filing format increases the speed of filing and locating information and eliminate misfiles. Coding dates separates active from inactive files, Coding file groups alerts users to appropriate actions.

**You provide the file list on MS Excel, and DATAFILE will print all your labels, apply them to your folders, then box and ship them for you.**

# Fasteners

## FOLDERS

### Dataclip / Flexiclip Fastener\*

Unique fasteners that convert any file folder into a loose leaf format, the flexible 3-piece construction permit pages to be removed and inserted at any point, as well as firmly securing documents. Dataclip tubecards allow the fastener to attach to any folder within seconds. The ideal solution for 50mm of secure document storage. Sold separately or DATAFILE can **install** them into your folders for you, just quote the install code.

Product#	Install#	Description	Unit Qty.
1325-30	5002-DC	Dataclip Fastener (U-Piece, Pressure Plate & Tubecard)	Pkt of 100
1325-TC		Dataclip Tubecard Only	Pkt of 100
1325-75	5005-DC	Dataclip Fastener (U-Piece, Pressure Plate & Tubecard, Install Only)	Pkt of 75
1327-02		Flexiclip Fastener (U-Piece, Pressure Plate & Flexiclip)	Pkt of 100
1327-00		Flexiclip Only	Pkt of 100

\*Also known as "Mediclip".

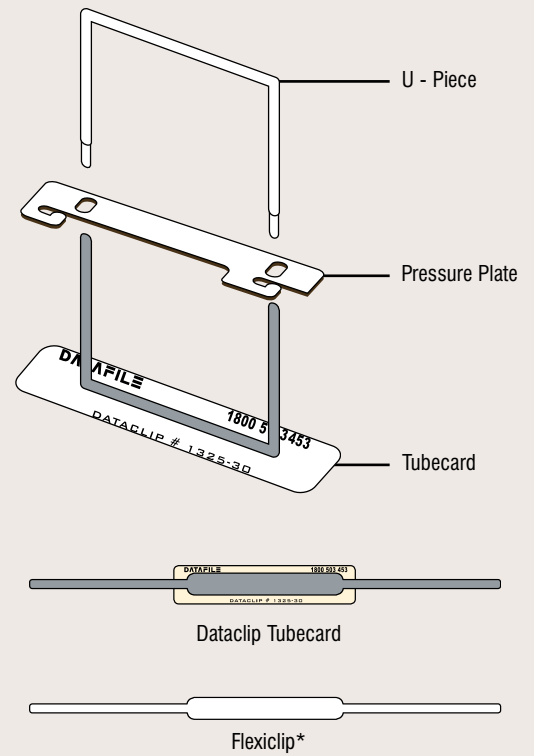

### Foamclips & Heatseal Fasteners

A perfect way for organising two-hole punched papers into folders, these fasteners bond permanently to folders surfaces. Foamclips are easy to use; just peel off the backing paper and press into place. Heatseal fasteners are machine installed by DATAFILE.

Product#	Install#	Description	Unit Qty.
F1325		Foam Clip Fastener (Not Installed Only)	Pkt of 100
1326-00	5001-HS	Heatseal Fastener (Installed Only)	Each

### TB Patch Fastener

A perfect way for organising one-hole punched papers into file folders. Combine the pin fastener with the fabrene patch to create the sturdiest holder. The fabrene patch and pin fastener can be ordered in rolls of 1000 or DATAFILE can install them for you.

Product#	Install#	Description	Dimensions (mm)	Unit Qty.
F1330	5003-TB	TB Patch Fastener	50mm x 50mm	Roll of 1000
1330-SP		Split Pins for TB Patch	25mm	Pkt of 200
1331-SP		Split Pins for TB Patch	38mm	Pkt of 200

### Additional Fastener Options

Product#	Install#	Description	Unit Qty.
SPCLIP	5006-SP	Springclip Fastener	Each
DCLIP-35	5007-D35	D-Ring Clip Fastener, 2 Ring, 35mm	Each
DCLIP-70	5007-D70	D-Ring Clip Fastener, 2 Ring, 70mm	Each
FA-005-RBC		D-Ring Binder Clamp	Each

